

series 272

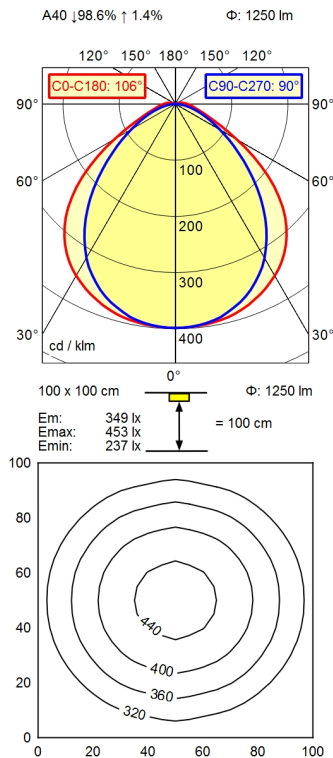

light source
 work equipment
 connected load
 power consumption
 luminous flux
 luminous efficiency
 light distribution
 direct ratio
 beam angle
 colour temperature
 colour temperatur
 color rendering index (CRI)
 chromaticity tolerance LED
 glare control
 luminance (L65)
 unified glare rating (4H 8H)
 system of protection
 class of protection
 technology
 operation
 housing
 weight (net)
 mains lead
 fastening
 dimension
 light output
 side part
 special features

LED
 without
 230V, 50/60Hz
 env. 16 W
 approx. 1.250 lm
 approx. 78 lm/W
 direct
 approx. 99 %
 100°
 neutral white
 approx. 5.000 K
 >= 80
 < 4 SDCM
 diffuser foil
 <= 16000 cd/m²
 <= 25
 IP 67
 I
 switchable
 external
 acrylic (PMMA), clear
 env. 1,1 kg
 connector; series 272
 pipe clamp (accessory)
 A=370 mm
 D= 316 mm
 A with screwed cable gland
 light forming